

SpaceSaver | ME.200.13

Aboveground pool step

THE INDUSTRY'S LARGEST 2 HANDRAILS DROP-IN STEP

The SpaceSaver is specially designed for aboveground pools with a deck and comes with two aluminium handrails.

It is vented for increased water flow to prevent algae growth. With step cups, deck flanges, and front-loading ballast.

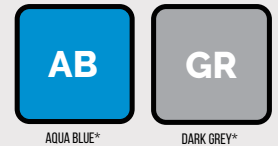
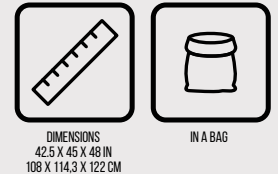
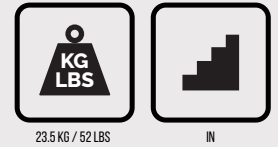
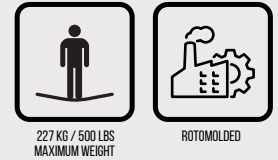

*LIMITED QUANTITY



Add some light!

INNOVALITE
9015-RGB/BT

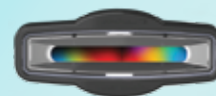

- Easy to install
- Choice of white LED lights or colors, Bluetooth-controlled

701-0058 / ME200.13_EN REV01/20
AVAILABLE: QC | CA | US | INT

For more information, visit
www.innovaplas.com

SpaceSaver | ME.200.13

Aboveground pool step

- Slip-resistant surfaces
- Outstanding resistance to UV rays
- Step to deck only.
- Meets current and proposed ISPC standards

FRONT-LOADING COUNTERWEIGHT SYSTEM

This simple, removable counterweight system not only offsets flotation but also makes winterizing your step easier.



STEP CUPS

THE ULTIMATE IN LINER PROTECTION!

Combined with the counterweight system, the Step Cups will maximize protection of your liner while keeping the step in position at the bottom of your pool by a suction concept. No need for sandbags with a deck application. (canadian patent #2,612,816 - U.S. patent pending)



ACCESS
ACCESS RESIN PRODUCTS

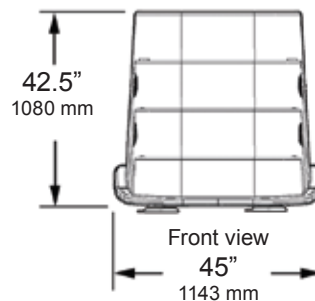
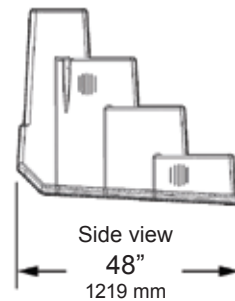

227 KG / 500 LBS
MAXIMUM WEIGHT



ROTMOLDED



235 KG / 52 LBS



IN



DIMENSIONS
42.5 X 45 X 48 IN
108 X 114.3 X 122 CM



IN A BAG



ABOVEGROUND POOL



WHITE



AQUA BLUE*



DARK GREY

*LIMITED QUANTITY

701-0058 / ME200.13.EN REV01/20
AVAILABLE: CC | CA | US | INT

For more information, visit
www.innovaplas.com